

RO VER A EDGE 16

CNC EDGEBANDING
MACHINING CENTRE

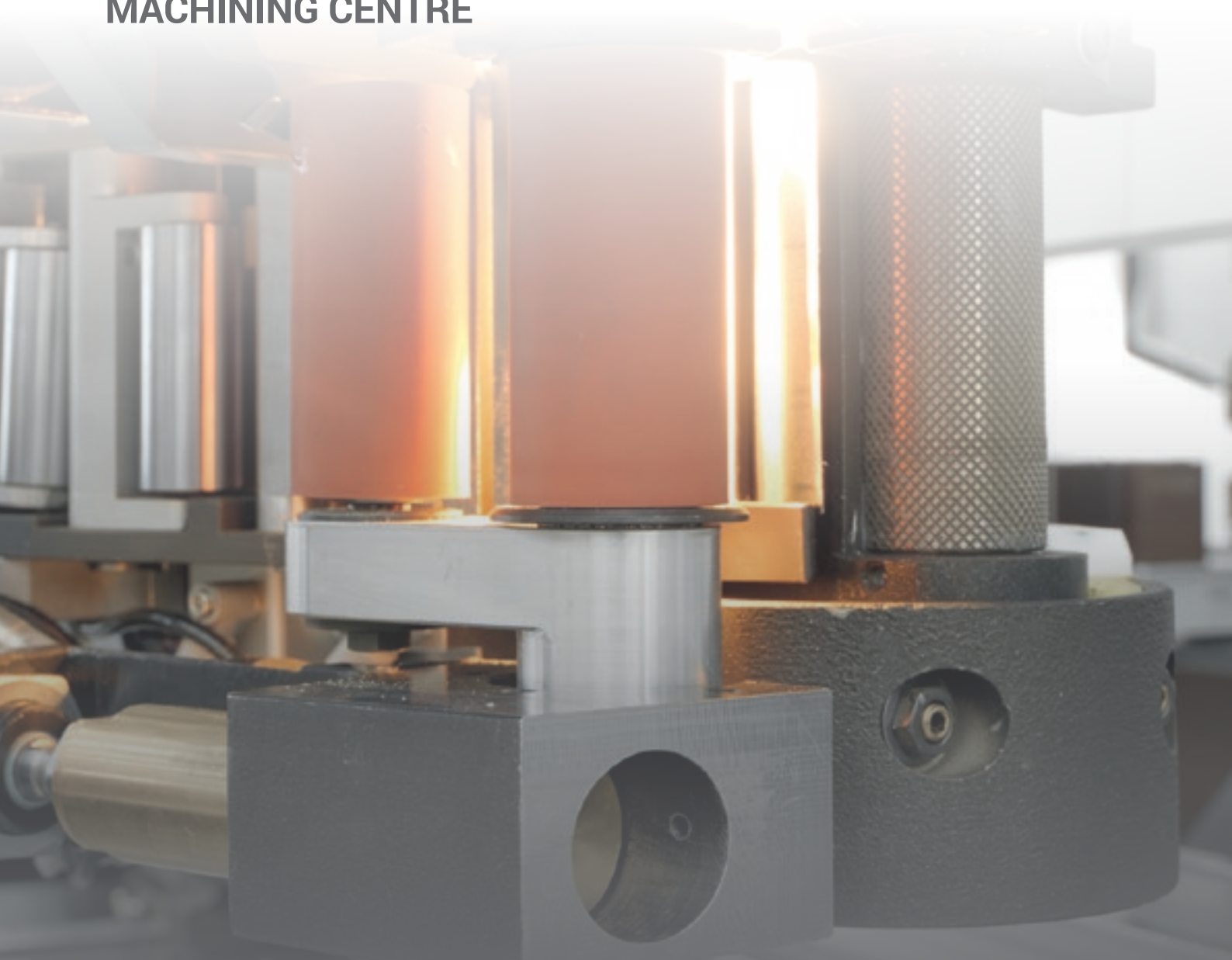

MANUFACTURING SHAPED AND EDGEBANDED PANELS WITH A SINGLE MACHINE

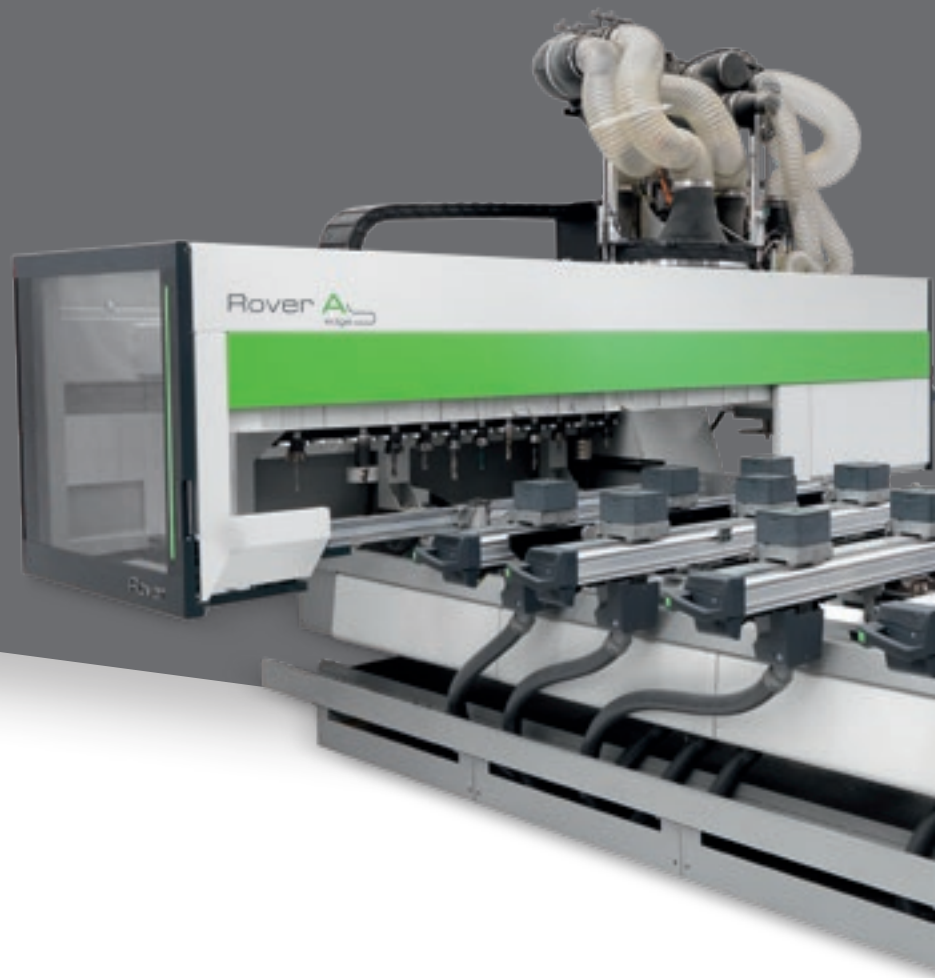

THE MARKET EXPECTS

a change in manufacturing processes which enables companies to **accept the largest possible number of orders**. This is coupled with the need to maintain high quality standards whilst offering product customisation with **quick and defined delivery times**, as well as responding to the needs of highly creative designers.

BIESSE RESPONDS

with **technological solutions** that influence and support technical expertise as well as process and material knowledge. **Rover A Edge 16** is an edgebanding machining centre that supports the machining of shaped panels, which can be edgebanded on a single, compact, high performance machine. It is ideally suited to small and large joineries that need to manufacture either odd size products or standard size products in small batches.



ROVER A EDGE 16

- ✓ MACHINE CUSTOMISATION DEPENDING ON PRODUCTION REQUIREMENTS
- ✓ OPTIMAL EDGE GRIP
- ✓ CYCLE TIME REDUCTION AND PRODUCTIVITY INCREASE
- ✓ OPTIMAL FINISH QUALITY
- ✓ REDUCED TOOL CHANGE OVER TIME
- ✓ HIGH-TECH BECOMES ACCESSIBLE AND INTUITIVE

MACHINE CUSTOMISATION DEPENDING ON DIFFERENT PRODUCTION REQUIREMENTS

A team of specialised sales engineers can understand production requirements and suggest the optimal machine configuration.

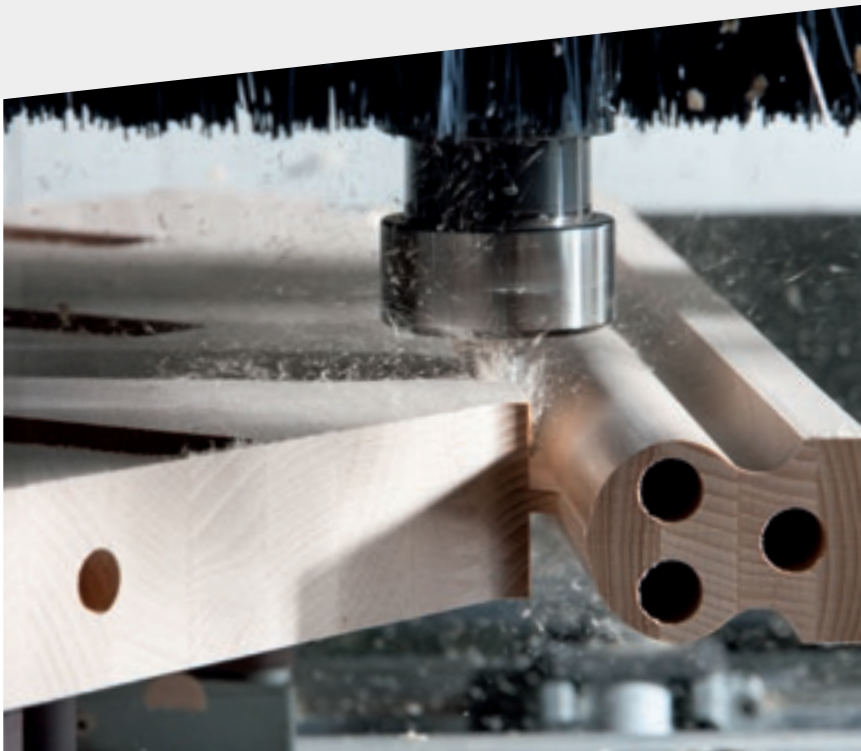

4-AXIS CONFIGURATION



A full configuration of the working unit supports the execution of different types of machining operations whilst ensuring a high finished product quality.



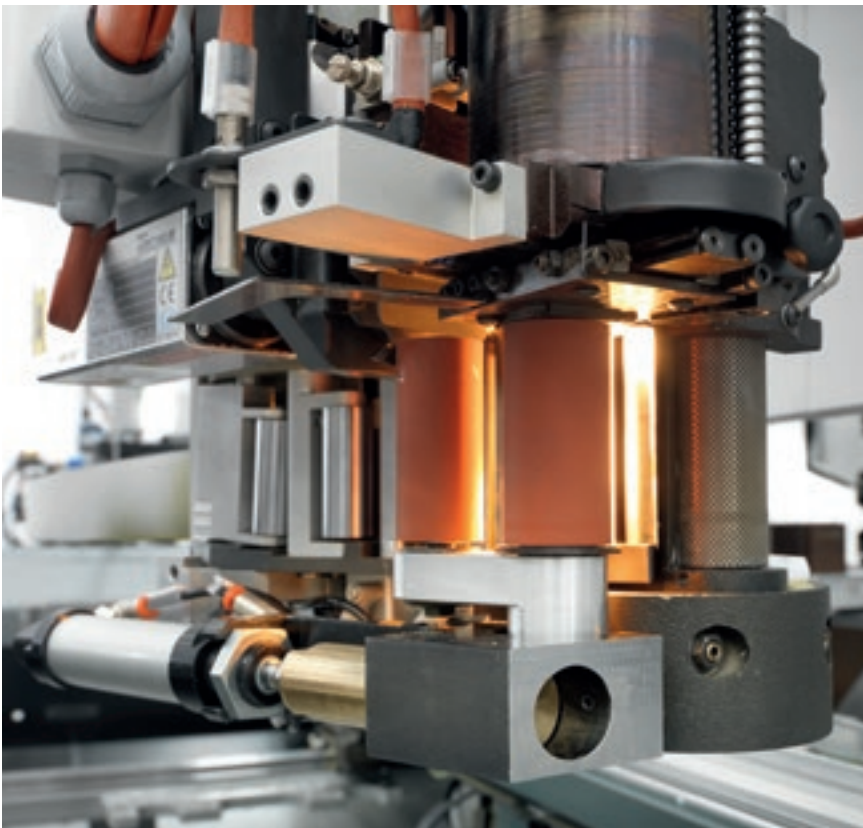
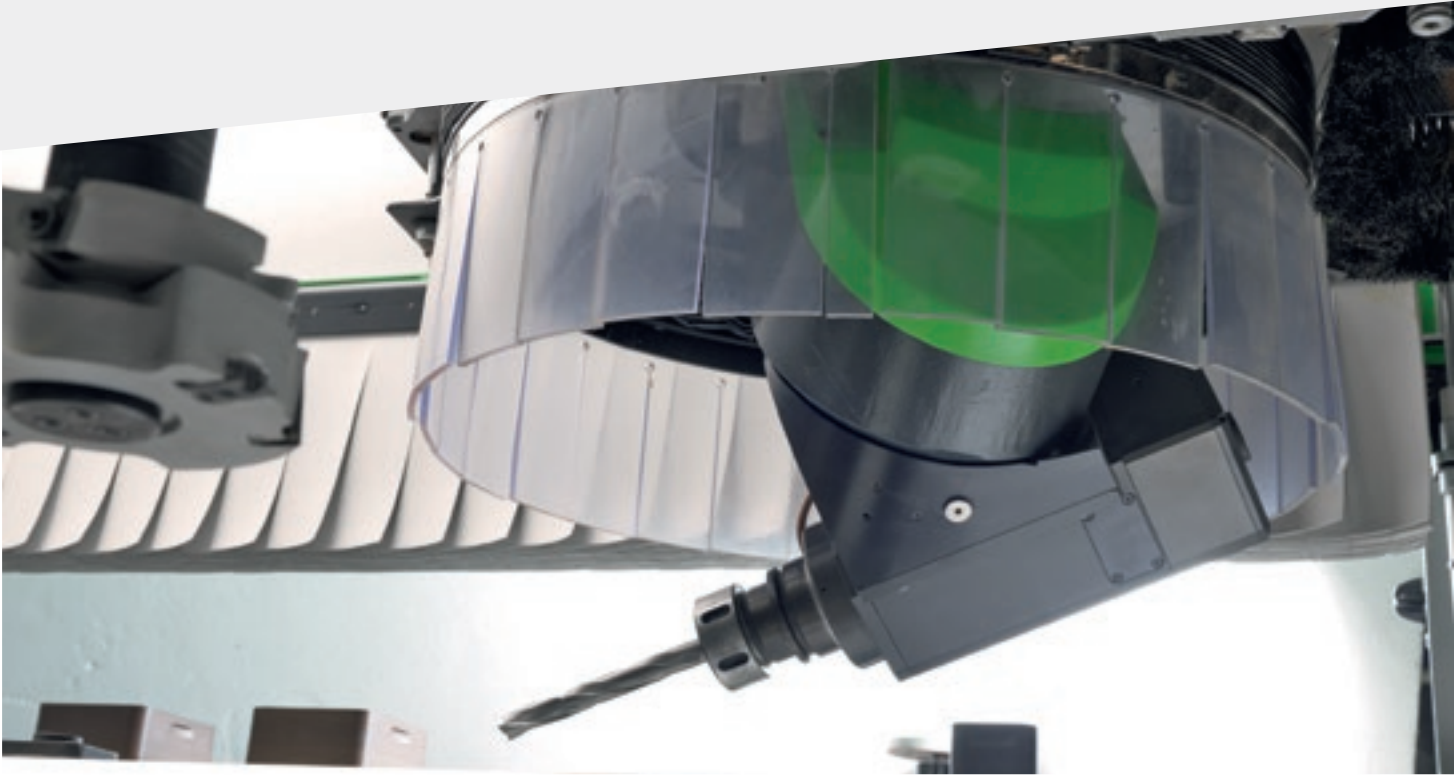

5-AXIS CONFIGURATION



The **cutting-edge 5-axis** working group supports the machining of pieces with complex shapes, ensuring quality and precision.

OPTIMAL EDGE GRIP

Optimal edge pressure quality during gluing on shaped panels thanks to the twinroller edge pressure system.



Similar to straight line edgebanding machines, **the glue is applied directly onto the panel** in order to ensure optimal adhesion quality. It supports the use of thin or transparent (3D) edges, as well as thicker and sturdier edges.



Glue feed occurs during the machining process via the granule feeding system within in integrated glue head. With the glue being stored in granules, only the required quantity is released for melting. This ensures optimal adhesion whilst preserving the glue characteristics.

FIRM, STABLE ADHESION

Biesse offers specific solutions for the use of polyurethane glues resistant to heat, humidity and water.



PU granule adhesives.



Additional glue pots fitted with quick-release electrical system for PU granule adhesives.



Nordson pre-melter for high production needs. An exclusive direct injection system for non-stop machining operations at high speed and consumption levels.

Biesse offers specific solutions for the highest quality of the finished piece through the use of RayForce System zero-joint technology.

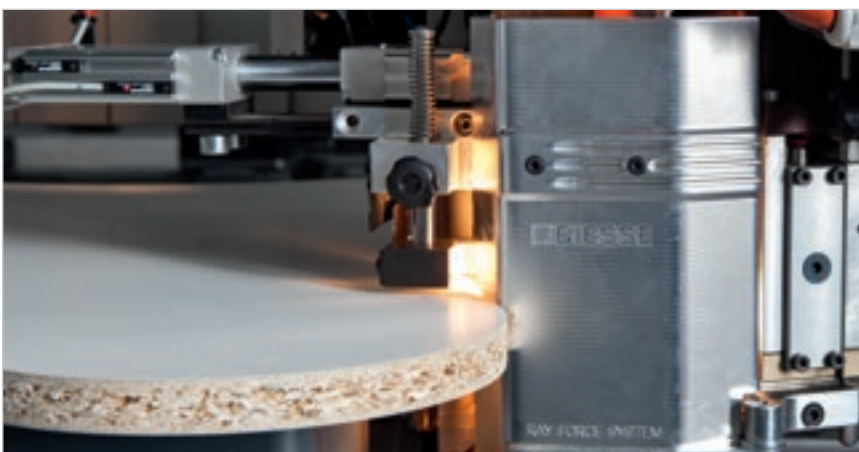

RayForce System equipment, interchangeable with the use of EVA or PUR glues, for the highest quality of the finished product.

ROVER EDGE

ROBUST EDGEBANDING

Maximum bonding, possibility of applying thin edges and 3D transparent edges, easy maintenance and panel cleaning during the machining cycle.

Edgebanding has always been based on applying glue directly to the panel; Biesse has followed this principle and applied it to straight edgebanding as well as shaped edgebanding performed by machining centres.



SOLUTIONS THAT INCREASE MACHINE PRODUCTIVITY



The automatic edging feeder, mounted on the X carriage, allows the user to change between thin or thicker edges during the same machining cycle.



Quick change of the coils with the banding material container positioned outside the safety fences.

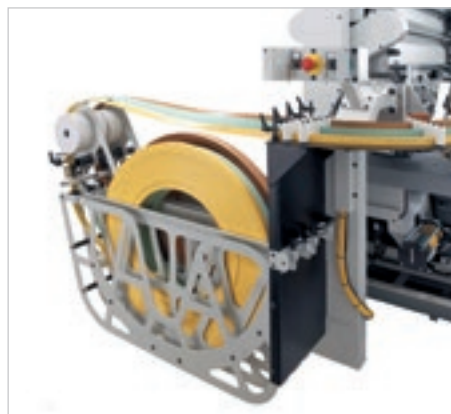

Thin or thick edges, either pre-cut or coiled, with automatic or manual feeding.

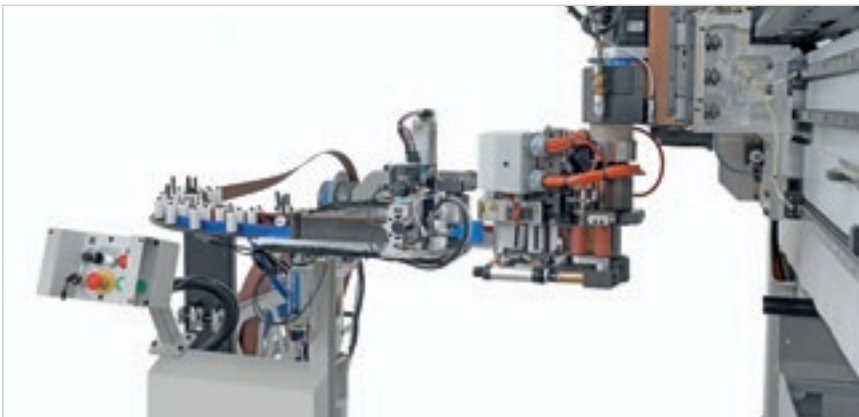

Y dual axis to carry out tool changes and edge feeding during machining.



Independent Z dual axis to efficiently support different types of boring heads for 9, 24 or 30 drills or multi-function tools.



16 position tool magazine for edge-banding operations.

MANY SOLUTIONS FOR PERFECT FINISHES

AGGREGATES FOR THE FINISHING OF THE UPPER AND LOWER PART OF THE EDGE APPLIED ON THE PANEL

ET60C



Trimming aggregate, 30 mm or 18 mm minimum internal radius with flat knives.

ETG60C



Trimming aggregate, glue scraper, 30 mm minimum internal radius.

ETS60C



Trimming aggregate, non-stick liquid, 80 mm minimum internal radius.

EGS60C



Edgebanding strip scraping aggregate, glue scraper, 30 mm minimum internal radius.

EF60B



Edgebanding strip finishing aggregate with three functions: trimming, edgebanding strip and glue scraping; 30 mm minimum internal radius.



Bench to facilitate the adjustment of the edgebanding strip finishing aggregates and can be used externally to the machine.

A COMPLETE RANGE OF AGGREGATES FOR ALL MACHINING OPERATIONS

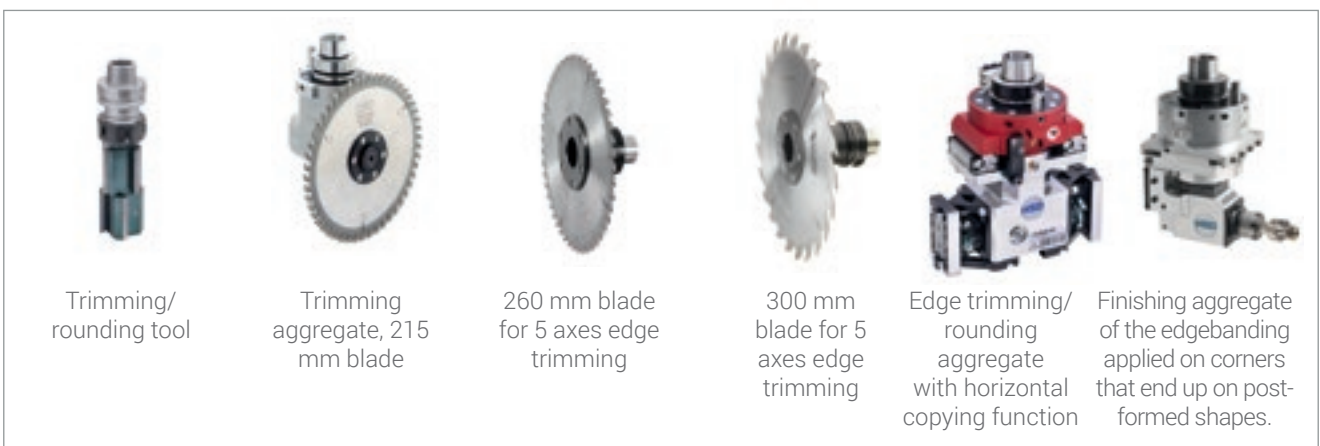

Trimming/rounding tool

Trimming aggregate, 215 mm blade

260 mm blade for 5 axes edge trimming

300 mm blade for 5 axes edge trimming

Edge trimming/rounding aggregate with horizontal copying function

Finishing aggregate of the edgebanding applied on corners that end up on post-formed shapes.

TOP-QUALITY FINISHED PRODUCT



Blower and anti-adhesive liquid dispensing aggregate.



Trimming aggregate with non-stick liquid delivery.



Brusher aggregate with glue removal liquid dispenser.



Cold or hot air blower unit to brighten up the colour of the edgelanding strip.



Blower unit.



4-outlet blower unit for edgelanding strip finishing aggregates.

A COMPLETE RANGE OF AGGREGATES



Aggregate for milling of 90 internal corners.



RAY FORCE SYSTEM

UNPARALLELED TECHNOLOGY

Biesse's high technology responds to increasingly complex market demands by developing an all-new technology like none other of its kind for the application of edges on shaped panels: RAYFORCE SYSTEM. Its revolutionary nature is based on an exclusive technique which uses infrared lamps to fuse a reactive layer. A solution that is comparable to AirForce System technology applied to linear edge.

The advantages are unmatched:

- maximum quality of finish,
- lower electrical consumption,
- ease of use.

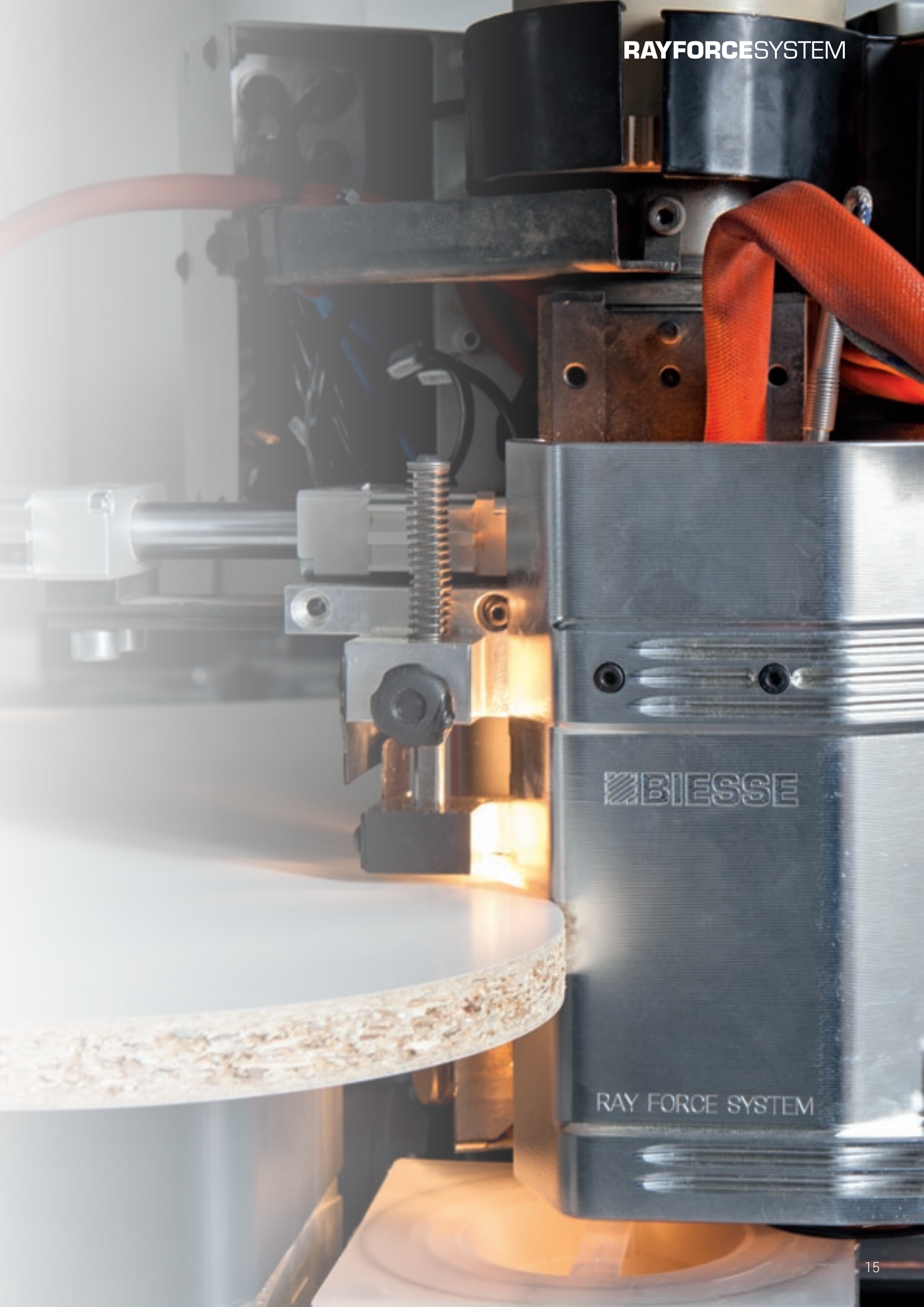

BIESSE

RAY FORCE SYSTEM

REDUCED TOOL CHANGEOVER TIME

The Biesse work table is guaranteed to hold the work piece securely in place and ensures quick and easy tool changeover.



Hyperclamps
for rigid and precise locking.



Modules for vacuum locking system. Jig equipped with rubber components to increase the resistance against horizontal forces exerted during edgebanding operations.



ATS (Advanced Table-Setting System)
For the quick and easy manual positioning of the clamping systems.



SA (Set Up Assistance)
The assisted set-up system, indicates to the operator where to position the panel, pods and rails to avoid potential collisions with the tool.

EPS (Electronic Positioning System)
supports the automatic reconfiguration of the entire work area in less than 30 seconds. Positions work tables and carriages by means of separate motors, i.e. without engaging the operating section. The positioning of the area's pods and rails is performed during machining, whilst the machine is working on the opposite area.

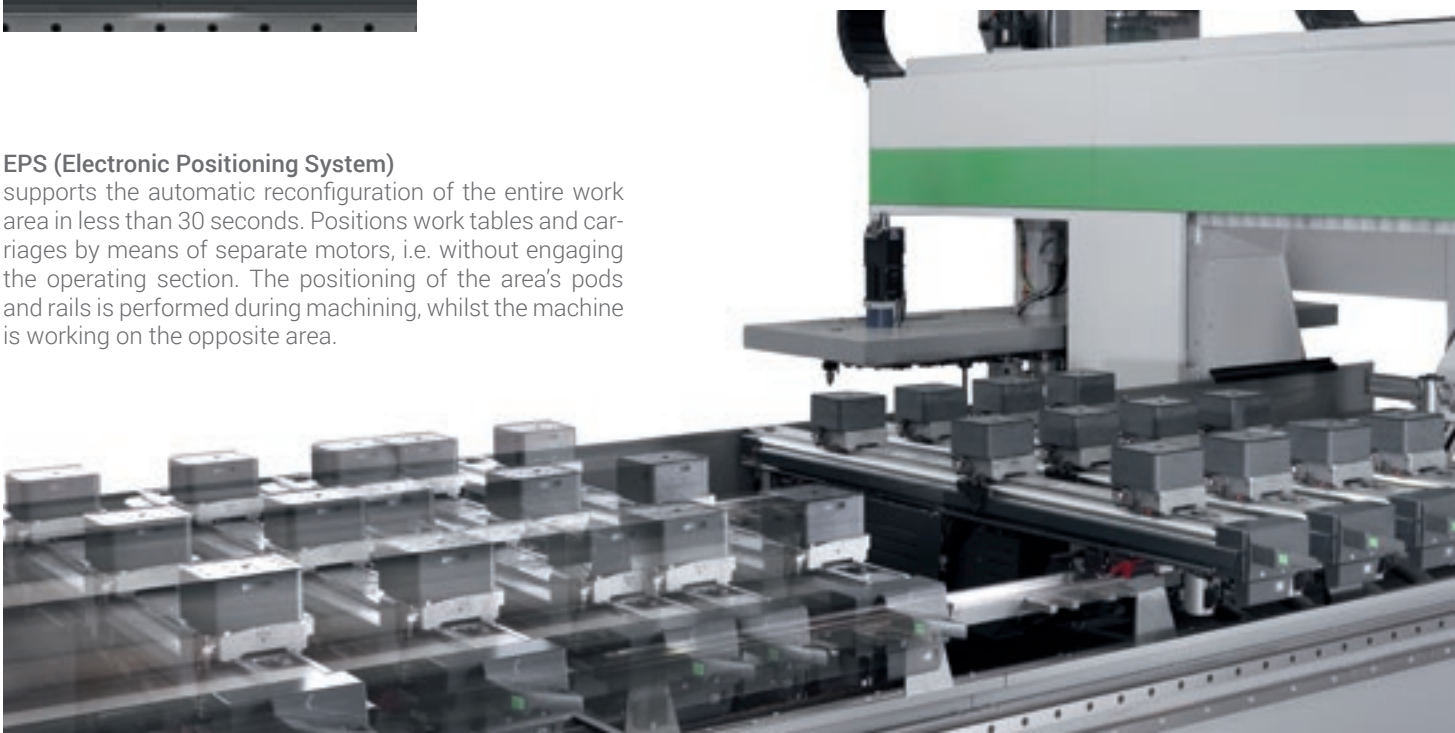

THE MACHINE CAN HOUSE UP TO 28 AGGREGATES AND TOOLS.



It is possible to switch from one machining operation to the next with no need for operator intervention for tool changes, thanks to the large number of tools and aggregates available in the tool magazine.



Quick and easy boring head change thanks to the exclusive spindle snap-on coupling system.



Facilitated access during tool change operations thanks to the **openable front cowl**.

ABILITY TO PROCESS LARGE SIZES

The open front cowl supports the loading of very-large sizes (up to 2100 mm in y axis) onto the machine, thus enabling the pre-sectioning phase to be omitted or machining operations to be performed for non-standard products.



The cross-head thickness tracer enables operators to measure panel dimensions with absolute precision.



Choose from a comprehensive range of bed sizes to facilitate the machining of all panel sizes.

- Rover A Edge 1632
- Rover A Edge 1643
- Rover A Edge 1659

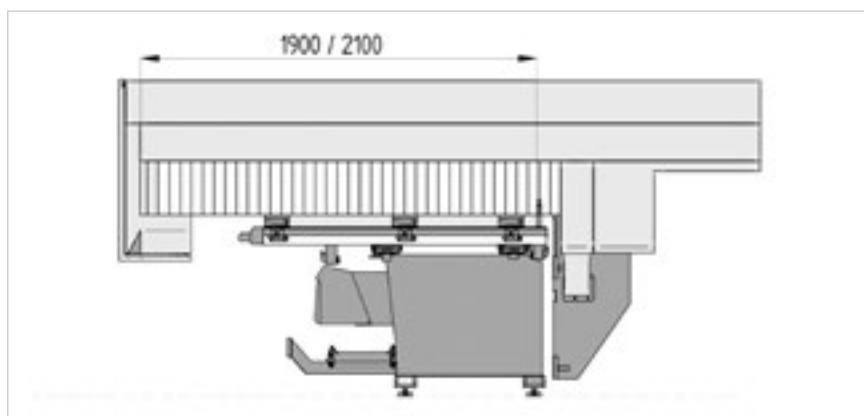



Two machines in one: the full functionality and quality of a true pantograph table are guaranteed by the **CFT (Convertible Flat Table)**, which supports the machining of thin panels, nesting and folding.

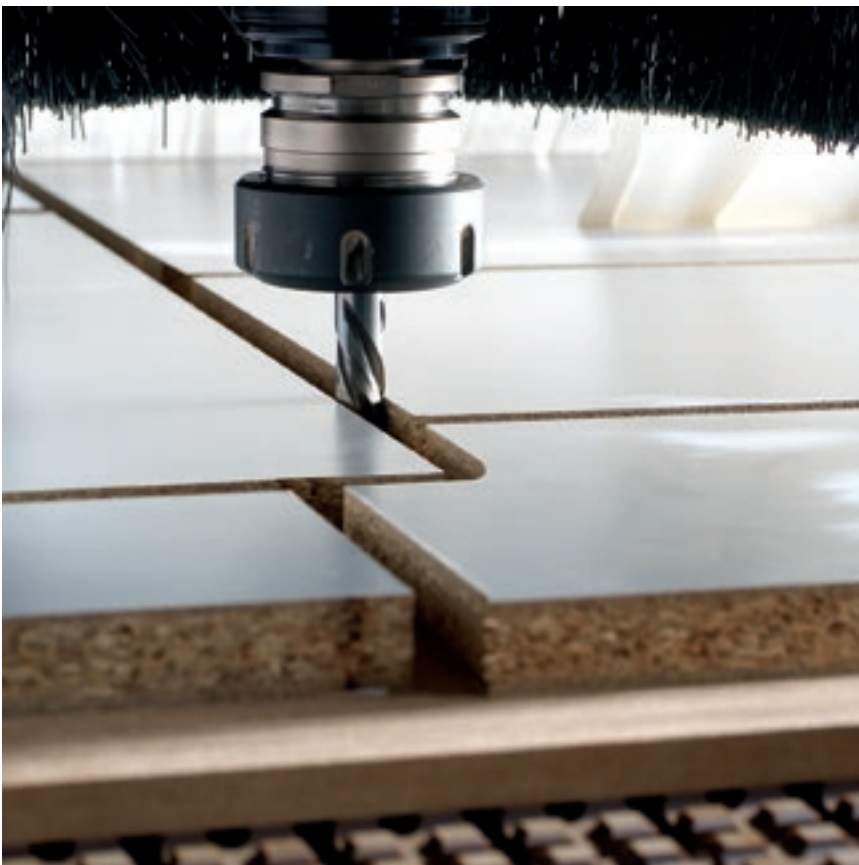

MAXIMUM OPERATOR SAFETY

Safety and flexibility thanks to the new bumpers combined with photocells with no footprint and dynamic tandem loading.



Pressure-sensitive floor mats enable the machine to operate at constant maximum speed.



Side curtain guards to protect the working unit, which are movable to enable the machine to work at maximum speed in total safety.



Remote control panel for direct and immediate operator control.



Maximum visibility of machining operation. **LED bar with 5 colours** showing machine status in real time.

OPTIMAL CLEANING OF MACHINED COMPONENTS AND WORK AREA



Motorised conveyor belt for the removal of chips and waste.



NC controlled chip **deflector**.



6-position adjustable suction hood.

LOADING AND UNLOADING SOLUTIONS

Synchro is a loading/unloading device that transforms the Rover machining centre into an automatic cell for producing a stack of panels autonomously (without the need for an operator):

- It eliminates the risk of damage in the case of heavy panels that need to be handled by 2 operators
- It's easy to use, because the machining centre program also contains the Synchro command instructions
- It has limited overall dimensions, and can be positioned to the left or right of the machining centre
- It comes with various configurations, depending on the size of the panels to be handled and the layout of the stacks.

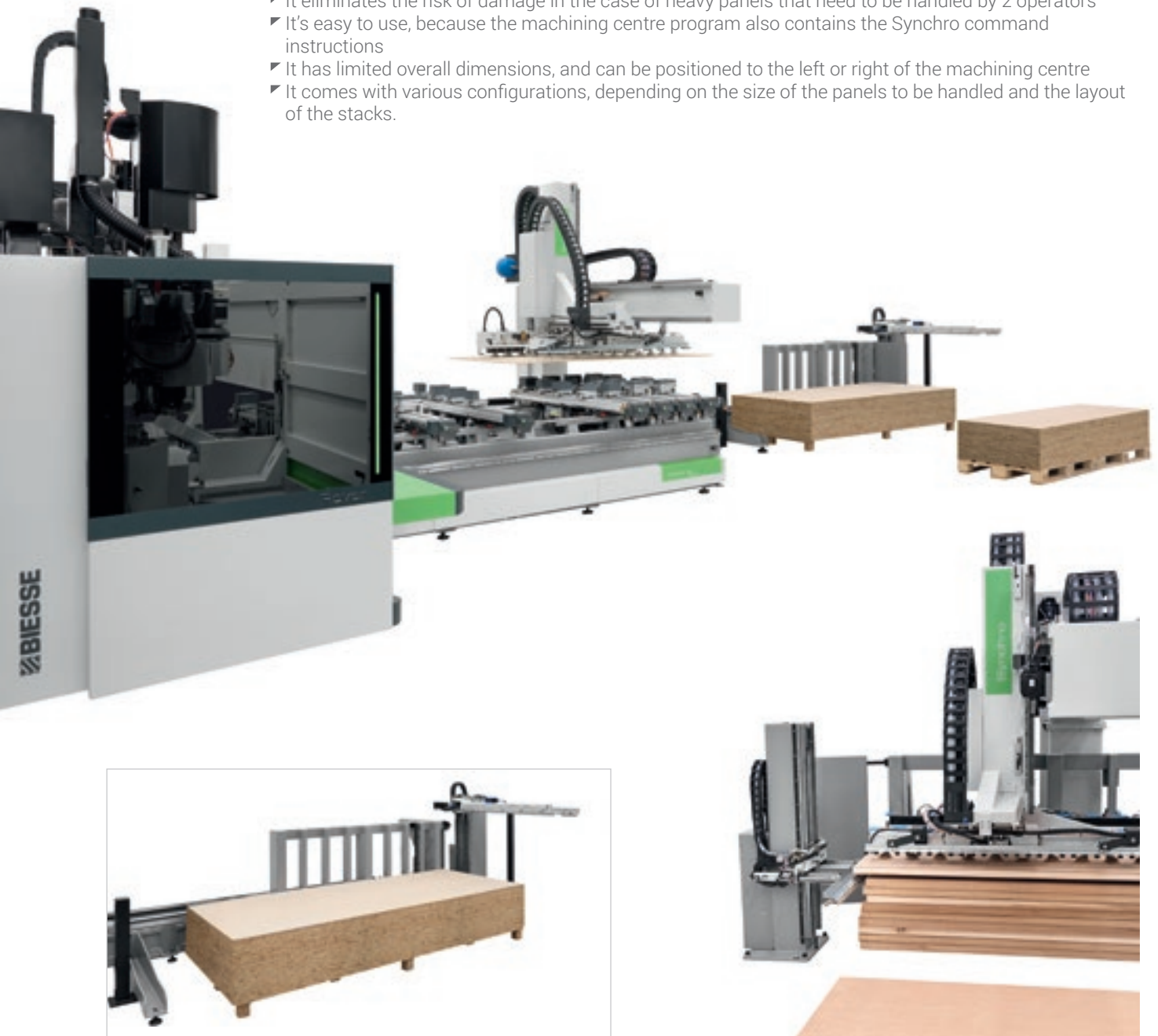

Mechanical detacher

Increases the reliability and repeatability of the automatic functioning cycle of the cell, compensating for the lack of alignment of the panels in the stack. It consists of a central or lateral mobile stop equipped with blowers to allow for the separation of the panels in the stack.

Automated cell for machining a batch of panels or doors.

Synchro can also machine stacks of different-sized panels, thanks to stack reference device and the panel pre-alignment cycle, which is performed while the machine is running, while the Rover machining centre processes the previous panel.

Panel pick-up device with automatic positioning of the suction cup holder rods

In accordance with the size of the panel to be picked up:

- No operator intervention is required to attach or remove the suction cup holder rods
- Idle time during format change operations is dramatically reduced
- The risk of collisions caused by incorrect tooling operations is reduced.
- Available in multi-zone mode with independent activation of the suction cups
- The suction cups can be configured with internal blowing to manage porous materials

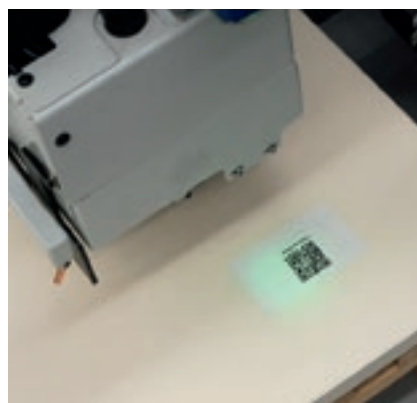

Two types of **bar code readers** are available for reading the bar codes on the top face and on the side face of the panel. These can be used to load the proper machining programme list avoiding operator error.

Dedicated configuration for the simultaneous loading/unloading of 2 panels, to maximise machining centre productivity:

- 0 operators
- 1 machining program
- 2 panels

THE MOST ADVANCED TECHNOLOGY CLOSE AT HAND

bTouch is an optional feature that can be purchased after purchase of the machine to enhance the functionality and the usage of the technology available.



bTouch is the new 21.5" touch screen which enables you to carry out all of the functions previously performed using the mouse and the keyboard, enhancing the direct interaction between the user and the device.

Perfectly integrated with the B_SUITE 3.0 interface (and with later versions) and optimised for touch, this solution is incredibly simple, and makes the best possible use of the Biesse software functions installed on the machine. The screen has a maximum resolution of 1920 x 1080 (Full HD) at 60 Hz.

Specifically, you can:

- ✔ Create any CAD programme (including parametric programmes), with layouts and machining operations
- ✔ Move, rotate and increase the size of objects (panel, NC machine, tool etc.) present within the CAD/CAM area
- ✔ Quickly and simply complete warehouse tooling, by dragging the tools into their designated places
- ✔ Prepare the machine for the correct positioning of the panel (machine set-up), moving tables and carriages into the desired position
- ✔ Send a programme machining list, change the parameters and send it to the NC machine for processing
- ✔ Manage all of the soft-console controls

INDUSTRY 4.0 READY



Industry 4.0 is the new industry frontier, based on digital technologies and on machines that speak to companies. The products driving this revolution can communicate and interact independently within production processes, which in turn are connected via intelligent networks.

Biesse is dedicated to transforming the factories owned by our customers into real-time factories that are ready to provide digital manufacturing opportunities. Intelligent machines and software become indispensable tools that facilitate the daily work of those who machine wood and other materials on a daily basis.

INDUSTRY 4.0 READY

WORKING UNIT CONFIGURATION

4-AXIS CONFIGURATION

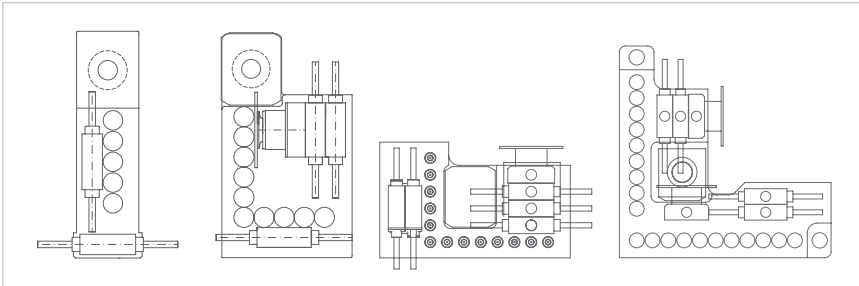

Available boring heads from 9 to 30 drill positions:
BHZ 9 - BHZ 17 L - BHZ 24 L - BHZ 30 2L.

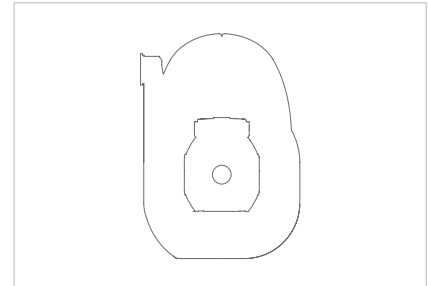

Milling unit with air or liquid cooling, ISO 30, HSK F63 and HSK E63 couplings and power from 13.2 to 19.2 kW.

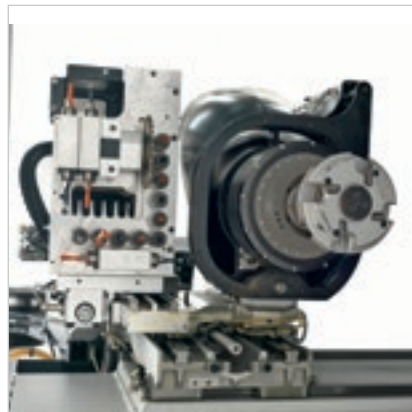

5-AXIS CONFIGURATION

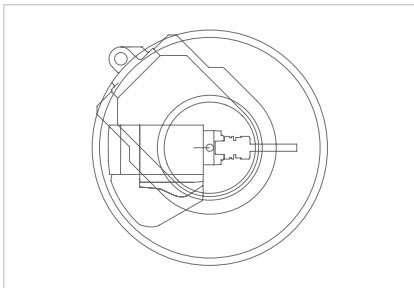
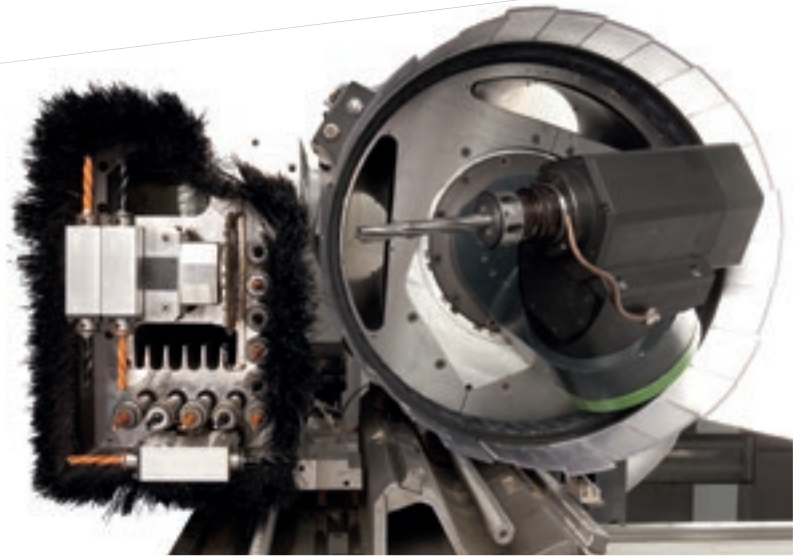

5 axes 13 kW with 24000 rpm
or 16 kW with 18000 rpm.

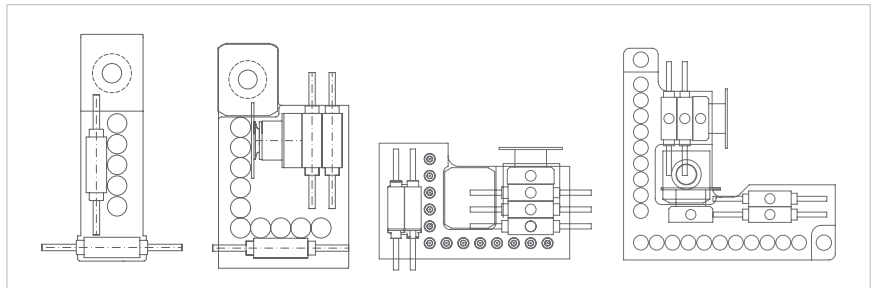

Available boring heads from 9 to 30 spindles:
BHZ 9 - BHZ 17 L - BHZ 24 L - BHZ 30 2L.



HIGH-TECH BECOMES ACCESSIBLE AND INTUITIVE



B_SOLID IS A 3D CAD CAM SOFTWARE PROGRAM THAT SUPPORTS THE PERFORMANCE OF ANY MACHINING OPERATION THANKS TO VERTICAL MODULES DESIGNED FOR SPECIFIC MANUFACTURING PROCESSES.

- Planning in just a few clicks.
- Simulating machining operations to visualise the piece ahead of manufacturing and have some guidance for the planning phase.
- Virtual prototyping of the piece to avoid collisions and ensure optimal machine equipment.
- Machining operation simulation with a calculation of the execution time.



SIMPLIFYING EDGEBANDING PROGRAMMING



B_EDGE IS AN ADDITIONAL MODULE INTEGRATED IN B_SUITE. MAKING FULL USE OF THE CAPACITIES OF THE SUITE, B_EDGE SIMPLIFIES THE PROGRAMMING OF THE EDGEBANDING PROCESS.

- Automatic generation of the edgbanding operation sequence.
- Easy to understand and operate.
- Simplified management of edgbanding strips and edgbanding devices

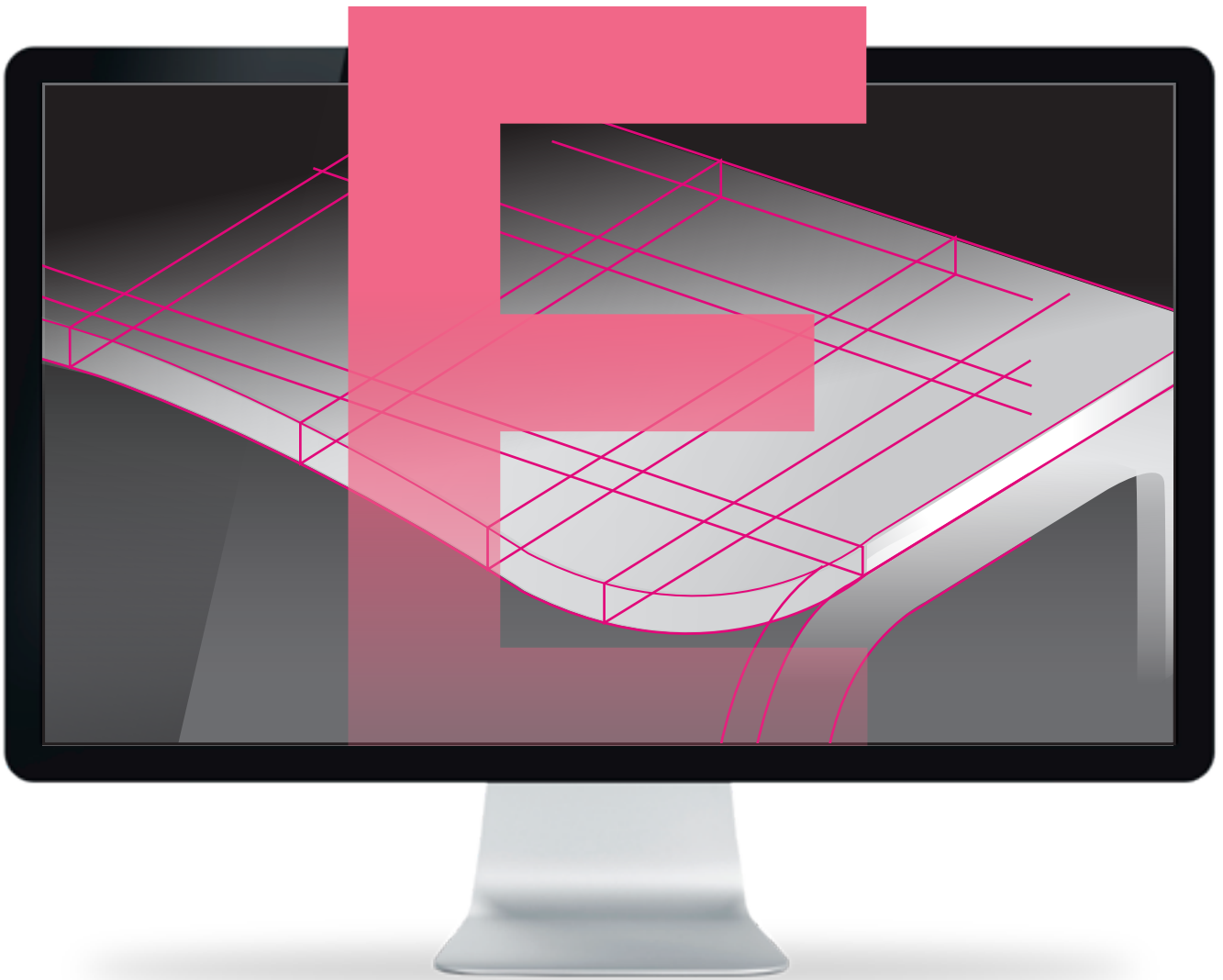

MANAGING PRODUCTION IN A SIMPLE, USER-FRIENDLY MANNER



SmartConnection is a web-based solution that can be used by any device.



SMARTCONNECTION IS A SOFTWARE PACKAGE FOR MANAGING JOB ORDERS WITHIN THE COMPANY - FROM THE GENERATION PHASE TO SCHEDULING AND ACTUAL PRODUCTION START-UP - IN JUST A FEW SIMPLE, INTUITIVE STEPS.

THANKS TO SMARTCONNECTION, THE PRODUCTION SITE MACHINES CAN BE LINKED UP TO TRANSFORM THE COMPANY INTO A 4.0 ENTITY.

MANAGE THE JOB ORDER



PLAN

SMART CONNECTION

Powered by Retuner



SCHEDULE

WORK



Biese is extending SmartConnection across all geographical areas.
To check availability in your country, get in touch with your commercial contact.

SOPHIA

GREATER VALUE FROM MACHINES

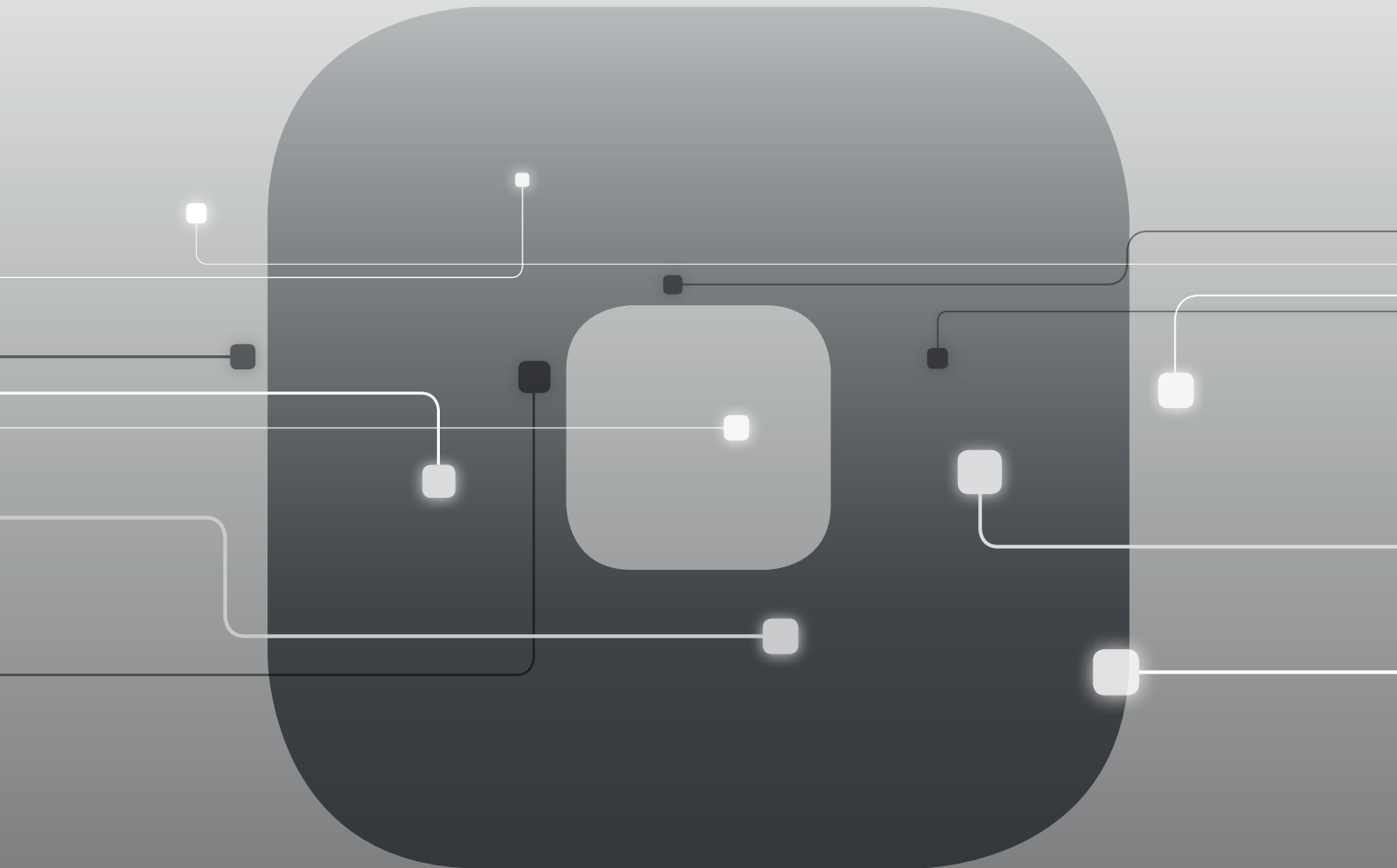

SOPHIA is the IoT platform created by Biesse in collaboration with Accenture which enables its customers to access a wide range of services to streamline and rationalise their work management processes.

It allows alerts and indicators to be sent to the customer in real time, in relation to production, the machines used and the type of process carried out. These are detailed instructions for more efficient use of the machine.

□ **10% CUT IN COSTS**

□ **50% REDUCTION
IN MACHINE DOWNTIME**

□ **10% INCREASE
IN PRODUCTIVITY**

□ **80% REDUCTION IN PROBLEM
DIAGNOSTICS TIME**

**SOPHIA TAKES THE INTERACTION BETWEEN
CUSTOMER AND SERVICE TO A HIGHER LEVEL.**

iOT
SOPHIA

IoT - SOPHIA provides a comprehensive overview of the specific machine performance features, with remote diagnostics, machine stoppage analysis and fault prevention. The service includes a continuous connection with the control centre, the option of calling for assistance from within the customer app (such calls are managed as priorities), and an inspection visit for diagnostic and performance testing within the warranty period. Through SOPHIA, the customer receives priority technical assistance.

PARTS
SOPHIA

PARTS SOPHIA is the easy new, user-friendly and personalised tool for ordering Biesse spare parts. The portal offers customers, dealers and branches the chance to navigate within a personalised account, consult the constantly updated documentation of the machines purchased, and create a spare parts purchase basket indicating the real time availability in the warehouse and the relative price list. In addition, the progress of the order can be monitored at all times.

 **Biesse**

TECHNICAL SPECIFICATIONS

WORKING TABLE

		X1 milling	Y1 milling	X2 edgebanding	Y2 edgebanding	Z1 milling modules H74	Z2 milling modules H29
Rover A Edge 1632	mm	3228	1580	2300	1500	200	245
	inches	127,1	62,2	90,6	59,1	7,9	9,6
Rover A Edge 1643	mm	4320	1580	3300	1500	200	245
	inches	170,1	62,2	129,9	59,1	7,9	9,6
Rover A Edge 1659	mm	5920	1580	4900	1500	200	245
	inches	233,1	62,2	192,9	59,1	7,9	9,6

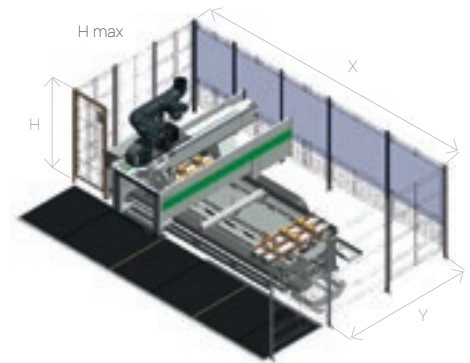

FOOT PRINT

CE	Loadable panel		X	X with outer edge magazine	Y	H	H max 4 axis	H max 5 axis
Rover A Edge 1632	belt operated 2100	mm	7045	7884	5387	2000	2400	2700
		inches	277	310	212	79	94	106
	with bumper and photocells 2100	mm	7045	7884	5437	2000	2400	2700
		inches	277	310	214	79	94	106
Rover A Edge 1643	belt operated 2100	mm	8078	8917	5387	2000	2400	2700
		inches	318	351	212	79	94	106
	with bumper and photocells 2100	mm	8078	8917	5437	2000	2400	2700
		inches	318	351	214	79	94	106
Rover A Edge 1659	belt operated 2100	mm	9681	10520	5387	2000	2400	2700
		inches	381	414	212	79	94	106
	with bumper and photocells 2100	mm	9681	10520	5437	2000	2400	2700
		inches	381	414	214	79	94	106

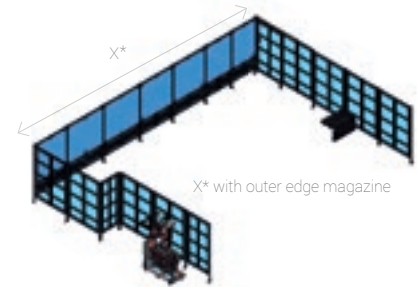

WORKING TABLE SYNCRO

Length (min/max)	mm/inch	400/3200* - 16/126*
Width (min/max)	mm/inch	200/2200* - 8/87*
Thickness (min/max)	mm/inch	8/150 - 0,3/6
Weight (1 panel/2 panels)	kg/lb	150/75 - 331/165
Useful height of stack	mm/inch	1000 - 39
Height of stack from ground (including 145 mm Europallet)	mm/inch	1145 - 45



(*) the Min and Max values may vary in accordance with the configurations of Syncro and the Rover machining centre to which Syncro is linked.

The technical specifications and drawings are non-binding. Some photos may show machines equipped with optional features. Biesse Spa reserves the right to carry out modifications without prior notice.

Weighted sound pressure level A in: Operator workstation LpFA 82 dB (A). Loading/unloading position LpFA 79 dB (A). Uncertainty factor K = 4 dB (A).

The measurement was carried out in compliance with UNI EN ISO 3746, UNI EN ISO 11202:2010 and subsequent modifications. The noise levels shown are emission levels and do not necessarily correspond to safe operation levels. Despite the fact that there is a relationship between emission and exposure levels, this may not be used in a reliable manner to establish whether further measures need to be taken. The factors determining the exposure level for the workforce include length of exposure, work environment characteristics, other sources of dust and noise, etc. i.e. the number of other adjoining machines and processes. At any rate, the above information will enable the operator to better evaluate dangers and risks.

MADE WITH BIESSE

ROVER A EDGE 16

THE BIESSE GROUP'S TECHNOLOGY SUPPORTS THE MANUFACTURING EFFICIENCY OF THE WORLD'S LARGEST FURNITURE MANUFACTURERS

"We were looking for a solution that would be so innovative that it would satisfy all our needs at the same time," states the manufacturing manager of one of the world's largest furniture manufacturers.

"Most of our production was already made using numerical control tools, but now everything that we produce is made with these technologies. This is why it was necessary to increase our production capacity. Biesse offered a solution that we liked very

much, a veritable range of processing centres and automatic magazines. Innovative, fascinating and decidedly powerful. With Biesse we defined a "turnkey" solution to be planned, built, tested, installed, inspected and commissioned within a precisely defined schedule".

Source: excerpt from an interview to the manufacturing manager of one of the world's largest furniture manufacturers.

BIESSE.COM

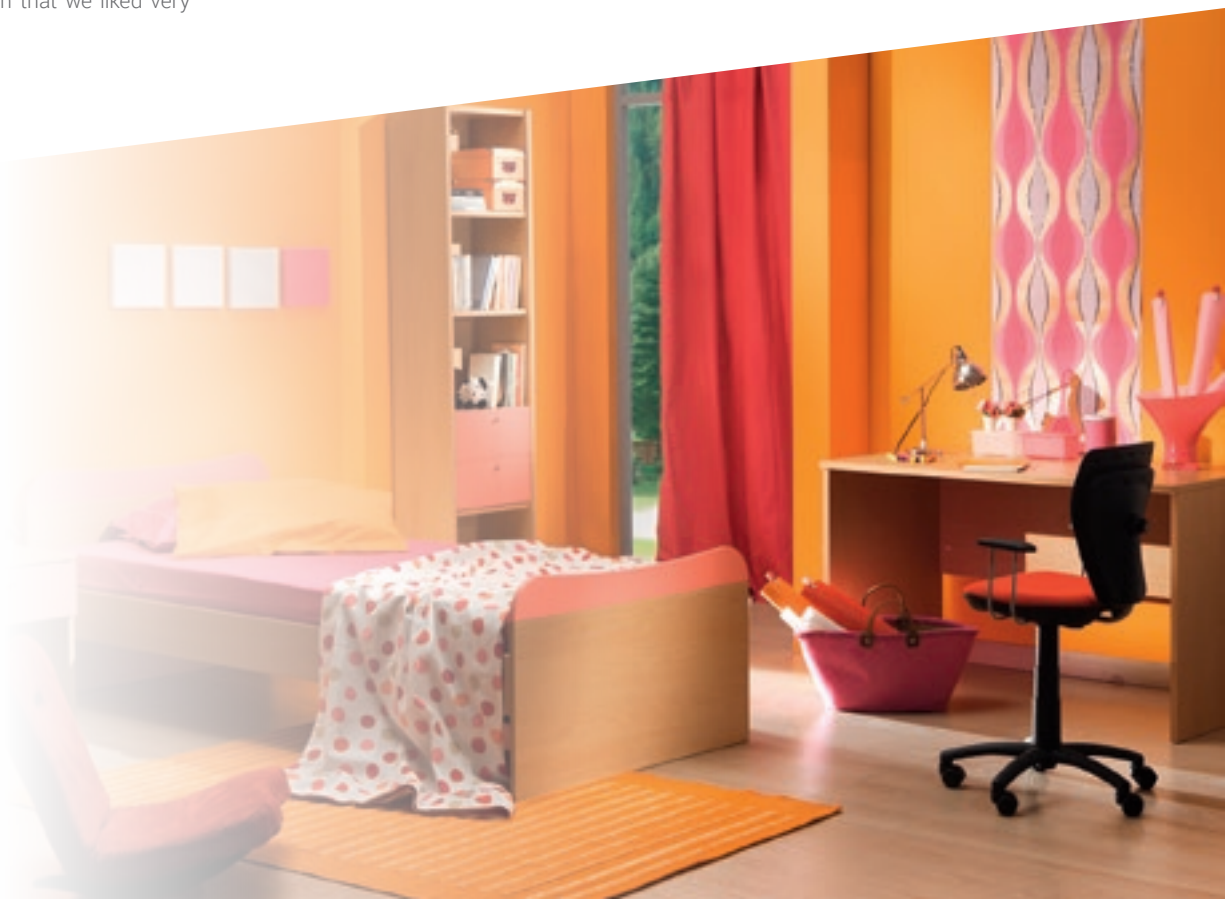

Founded in Italy,
international native.

We simplify your
manufacturing
to make the process
of any material



ur
g process
potential
I shine.

We are an international company that manufactures integrated lines and machines to process wood, glass, stone, plastic and composite materials and what will come next.

Thanks to our rooted competence nurtured by an ever-growing worldwide network, we support your business evolution – empowering your imagination.

Master of materials, since 1969.

Join the
Biesse world.

[biesse.com](https://www.biesse.com)



